

## INDEX

TR-200  
TRANSDUCER READOUT  
series 2

1. INTRODUCTION
2. CONTROLS & FUNCTION
3. QUICK SET-UP
4. CONNECTIONS & BATTERY CHARGING
5. CONNECTIONS - SERIAL O/P & INTELLIGENT I/P
6. SERIAL OUTPUT
7. CONNECTIONS – ANALOG O/P & TRIP RELAYS
8. ANALOG OUTPUT
9. DATA LOGGING
11. SET-UP OVERVIEW
12. CHANNEL, SERIAL No. & PEAK HOLD
13. CALIBRATION
14. DECIMAL POINT, BLANKING, FILTER & ZERO
15. KEY LOCKING
16. SPECIFICATION

LCM Systems Ltd.  
31-32 Somerton Industrial Park  
Newport Road  
Cowes, Isle of Wight  
PO31 8PB  
Tel: (01983) 299737  
Fax: (01983) 298283



## INTRODUCTION

The TR-200 transducer readout is a microprocessor based portable instrument designed to read load cells or pressure transducers with full bridge outputs of between 0.6 and 7.5mV/V for a full scale display of 19,999. Bridge resistances from 85Ω upwards can be accepted by the unit.

All adjustments are entered via the sealed keypad to enable the user to set zero, scaling, decimal points, least significant digit blanking, filtering, CAL checking and peak hold. Once the parameters are set, all the menu keys can be disabled to ensure keys are not pressed by mistake. The instrument can remember the parameters of up to 10 different load cells or pressure transducers. All values are retained in EEPROM for permanent storage (typical life 500,000 write cycles).

The instrument is fitted with a sealed re-chargeable lead acid battery which provides a period of at least 35hrs use, connected to a 350Ω bridge, between charges.

Further output options can be fitted to the main PCB. This enhances the units capabilities to provide RS-232 communication, data logging and printer interfacing. A facility exists within the instrument to externally switch channels either via a separate switch box or through intelligent plugs fitted to any load cell plugged into the unit (see separate technical note). An extra card can be fitted within the enclosure to provide voltage, current and trip outputs.

## CONTROLS & FUNCTIONS

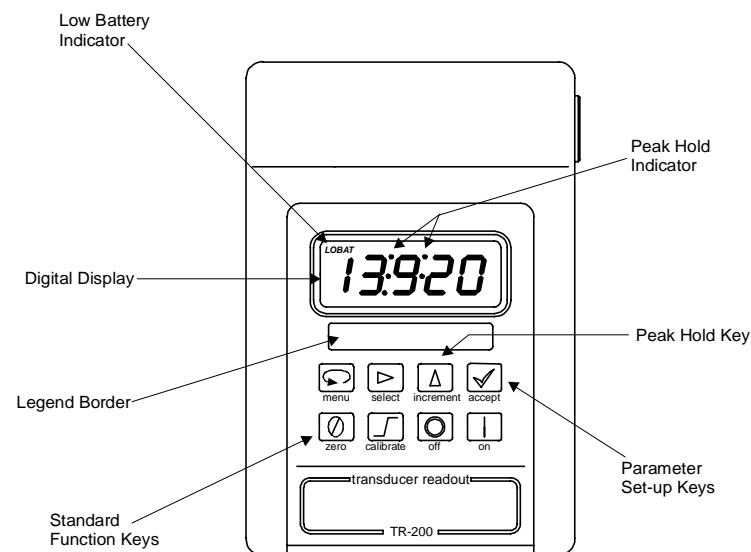







All the control of the instrument is via the front key pad. There is no need to open the enclosure except to select and fit a suitable CALIBRATION resistor (described in section 7).







An appropriate legend should be selected from the self-adhesive sheet provided and positioned into the border area located just below the LCD window.

The top row of keys are for setting various parameters into the unit and would normally be locked out of use after setting up. The exception to this is the Menu button (for changing channel) and the Peak Hold button which may be required for normal operation.

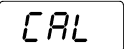
The lower row of keys are for general control of the instrument. The Zero key can be locked out if required. The Calibrate key provides a shunt calibration across one arm of the bridge and offers a useful check on the correct function of the instrument, transducer and gain setting.

## QUICK SET-UP

1. Connect load cell or transducer to TR-200
2. Press  to switch instrument ON
3. With no load on cell, press  to ZERO
4. Press  to check channel number  
 Press  to change,  
 to accept or  to move on.
5. Continue to step through  setting the following as required:
 

Decimal point position	<i>dEC</i>
Least significant digit blanking	<i>L5d</i>
Filtering	<i>F 1L</i>
6. Move on to 
 Load up cell to nominally 80% of full range or simulate load with   
 Set load on display with  and   
 Ensure load is steady on cell and press  to accept new CAL value.
7. Press  to switch unit OFF

## CONNECTIONS & BATTERY CHARGING

The TR-200 instrument is fitted with a BINDER 5 pin socket which, when mated to its respective plug, is sealed to IP65.

Additional mating plugs can be purchased quoting the part number 09-0113-10-05

Connections:

- PIN 1 + Excitation
- PIN 2 - Excitation
- PIN 3 + Signal
- PIN 4 - Signal
- PIN 5 + Charge

The instrument battery is charged through pins 2 & 5. The following graph indicates the typical battery decay, after a full charge, when connected to a 350Ω bridge. When first switching on the TR-200, press MENU and ON at the same time to obtain the BATTERY READING as stated on the left of the graph. With a lower bridge resistance, the battery life will be somewhat reduced. Re-charge with the charger provided as necessary.

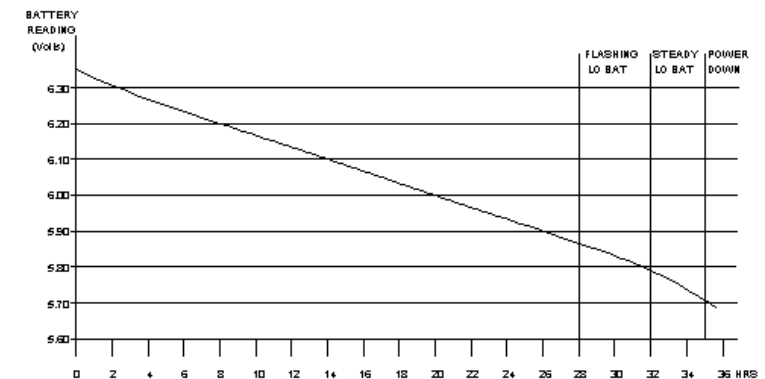

If leaving the instrument for a few months, without charging, it is recommended to remove one of the connections to the battery to eliminate any long term drain on the battery.

## CONNECTIONS – SERIAL OUTPUT & INTELLIGENT INPUT

If an extra 12 way socket is fitted to the TR-200, either or both of these options are fitted.

If the intelligent input option is fitted, any load cell plugged into this socket can automatically switch the channel and set up the various parameters associated with that load cell. To program this channel changing, pins E to J should be linked in the load cell free plug, as shown below. If the intelligent input is not being utilised then the 5 way socket can be used as normal for load cell input or external power/charge.

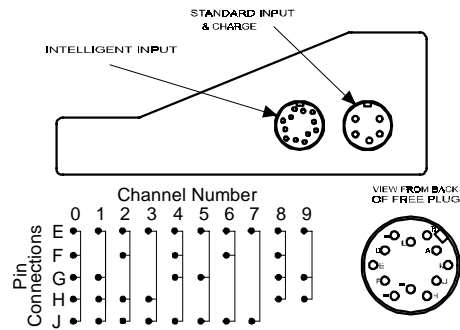

If the serial output option is fitted, then pins K, L & M should be used, as shown below.

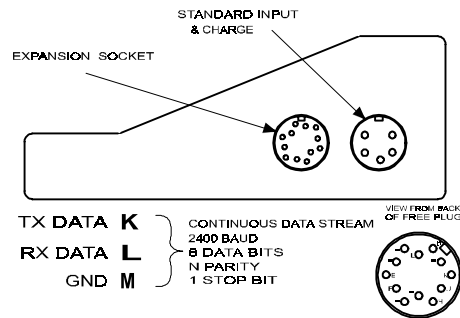





Additional 12 way mating plugs can be purchased quoting the part number 09-0129-70-12

## SERIAL OUTPUT

The TR-200 is normally supplied with the serial data continuously outputting after power-up. However, as a factory configurable option, the unit can be made to only output serial data on demand.

When this option is enabled, if normal continual serial output is required, this must be manually started and stopped by

pressing the  and  keys simultaneously. A single serial output can be triggered by pressing the  and  keys simultaneously.

The data stream is 2400 baud, 8 data bits, no parity, 1 stop bit.

The data string consists of a sign, followed by 5 numerical characters. If a decimal point is displayed, this forms an additional character. The following are possible output strings

+01234

+0123.4

-012.34

-01.234

The string terminator is carriage return, CHR\$(13)

## CONNECTIONS – ANALOG OUTPUT & TRIP RELAYS

If an extra 8 way socket is fitted to the TR-200, either or both of these options are fitted. The pin designations are as shown below:

VIEWED FROM FRONT OF SOCKET

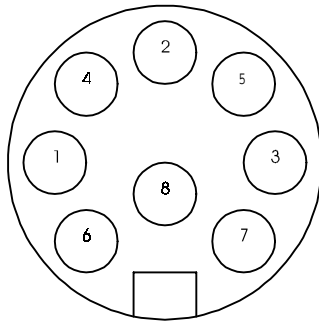

- |                          |                          |
|--------------------------|--------------------------|
| 1 Trip 1 Common          | 3 Trip 2 Common          |
| 4 Trip 1 Normally Open   | 5 Trip 2 Normally Open   |
| 6 Trip 1 Normally Closed | 7 Trip 2 Normally Closed |
| 2 Voltage/Current Send   |                          |
| 8 Voltage/Current Return |                          |

Additional 8 way mating plugs can be purchased quoting the part number 09-0129-70-08

If the analog output option is fitted, scaling is selected from the

**ADP**

page of the menu, using the graphs overleaf.

If the trip option is fitted, the trip levels are set in the **trP1**

and **trP2** pages of the menu, using the **0**, **▲** and



**▶** keys in the same way as the calibration number is set (see page 11). Each relay will energise when the displayed load exceeds the corresponding trip level.

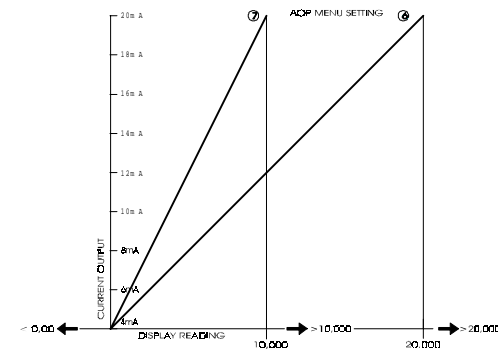
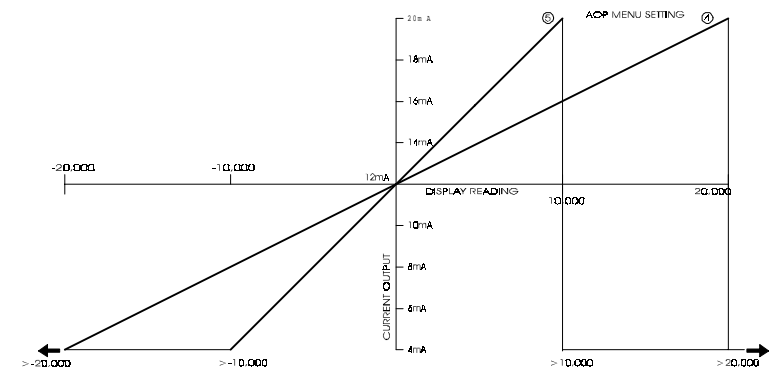
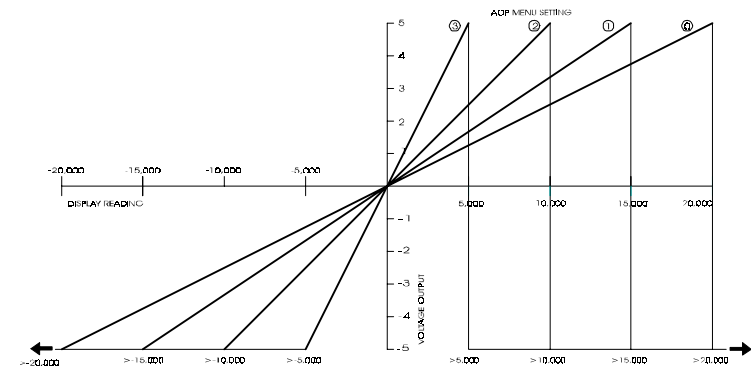









## ANALOG OUTPUT





## DATA LOGGING

If the TR-200 is fitted with data logging, the following applies.



To reset the log, press the  and  keys simultaneously, and then press  to reset the log and return to normal operation.

To initiate a sample, press the  and  keys simultaneously, and then use the ,  and  keys as required to set the Test Number (0 to 9999). Press  and in the same way use the ,  and  keys to set the Logging Interval (1 to 255, the number of 0.2sec intervals between continual samples). Press  to return to normal operation. Note that in the log, a Logging Interval of 0 denotes a single sample.

To take a single sample, press the  key. If the Peak Hold function is active, the sample logged will be the peak value (ie. the displayed value). When the Peak Hold function is exited, and the valley (minimum peak) is being displayed, this value may also be sampled.

To start continual sampling, press the  key twice in rapid succession. Two pairs of dots will appear in the display, which will momentarily indicate the Record Number as the sample is being taken. To stop continual sampling, press the  key again to return to normal operation. Note that the Peak Hold function is disabled when the unit is sampling continually.

## DATA LOGGING cntd.

To download the log to the serial port, press the  and  keys simultaneously, and then press the  key twice to skip past the Test Number and Logging Interval pages.

When ready to receive data, press  and, after the download is complete, the unit will return to normal operation.

A simple Quick Basic program to read in the serial data and produce a disk file of the log follows:





```
OPEN "COM1:2400,N,8,1,RS,DS,LF" FOR RANDOM AS #1
OPEN "LOG.DAT" FOR OUTPUT AS #2
```

```
DO
  INPUT #1, A$
  PRINT #2, A$
LOOP UNTIL A$="End Log"
BEEP
CLOSE #1
CLOSE #2
```

The form of each record in the log is as follows:

```
Hnnnn iii
Cq +rrrr
```



where n is the Test Number  
i is the Logging Interval  
q is the channel number  
r is the reading

If normal continual serial output is required, this must be manually started and stopped by pressing the  and  keys simultaneously. A single serial output can be triggered by pressing the  and  keys simultaneously.





## SET-UP OVERVIEW

The TR-200 has 10 independent channels that can be assigned to different transducers or to different engineering units for the same transducer. The set-up values such as zero, gain, decimal point etc. for each channel will be held in non-volatile memory and will remain the same until such time as the user wishes to change them.

Access to all channels and their parameters is through the MENU key. The sequence of setting up pages is as follows:

The digit flashing is the only one that can be changed. Values are scrolled round with the  key and the  key can set the ZERO value. Values greater than 9 can be shifted with the  key to build up the complete number.

Example: To enter 3450 as a calibration number

To zero the display press ZERO key once  0000  
To select the most significant digit press 3 times  0003  
To shift the digits to the left press once  0030  
To set the next digit press 4 times  0034  

Continue until correct, accepting the value with which takes the new value and writes it to memory.



 accepts any default value as displayed and passes the user on through the menu. Changing a channel number and accepting it passes the user out of the menu. This is useful when plugging in several transducers in sequence when it is only the reading of those transducers that need to be monitored.

The  key is not a software read key but just shunts one arm of the bridge with a resistor that can be changed internally by the user.

## CHANNEL NUMBERS, SERIAL NO. & PEAK HOLD

CHANNEL NUMBERS 

These range from 0 through to 9 and identify a unique set of parameters held in memory.

To change channel number ONLY, press  and select with the  key. Accept with the  key.

The instrument now takes you back to normal operation in the new channel number. To continue to change the parameters in the new channel selected, it is necessary to get back into it by pressing  twice to get past channel numbers and on to CAL.



### SERIAL No. & BATTERY STATE

Each TR-200 is manufactured with a unique electronic serial number which can be found when switching on, along with the state of the battery and channel number.

Press and hold the  key and switch ON. The battery voltage will first be displayed. See page 4 for the graph. Now, release the keys to display the serial number followed by the channel number that the TR-200 is set to.

### PEAK HOLD

The Peak Hold function, as set via the  key, is always available.



Peak Hold is active when the 4 flashing points are shown on the display. The peak capture time is independent of any display filtering. Press  again to display the valley (minimum peak) during the same period (the 4 points will be steady). Press  again to exit this function.

## CALIBRATION

An input of known quantity has to be applied to the instrument in order to set the CAL value. This input can either be from a true load or pressure being physically applied to the transducer

or simulated with the  key. This shunts the -ve supply to the -ve signal arm of the bridge with a selected resistor to simulate a +ve offset on the bridge. To gain access to the shunt resistor, open the enclosure by removing the four screws from the base cover. The resistor can be fitted to the sockets provided in the lower end of the pcb in the location marked CAL.

Before entering the menu, press  to set the display to zero.

When in the  page of the menu, enter the calibration value equivalent to the known quantity being applied either as a true load or pressure, or via the  key. Enter this value as described on page 11. Ignore decimal points at this stage.

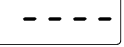
When the load is stable and is the same as the load keyed in and displayed, press the  key to accept the value and write it to memory. The instrument will now assume a linear relationship of input signal to displayed values from zero to full scale, based on this one calibration point and ZERO. The display will show  when calculating the instrument gain.

Error Message: When a calibration value has been entered but the instrument cannot achieve that value for the signal input, the display will show  and go back and await a new value to be entered or the input signal to be increased.

## DECIMAL POINT, DIGIT BLANKING & FILTERING

### DECIMAL POINT

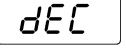
Decimal points can be set by the values 0, 1, 2 or 3 when in the  page.

### LEAST SIGNIFICANT DIGIT COUNT

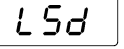
The least significant digit can be set when in the  page as follows:  
0 = count in 1's ie. all digits active  
1 = count in 10's ie. lsd always 0  
2 = count in 5's ie. lsd either 0 or 5

### FILTER

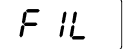
The response time of the display can be filtered when in the  page. Values from 0 to 3 can be set where 0 provides instantaneous response and 3 gives the most damped response.

### ZERO

Pressing the Zero key will tare off any offset on the instrument. This will be remembered on power down.

ZERO TRACKING is always active on  $\pm 3$  of the least significant digit. This means that if the display is within  $\pm 0003$ , the processor will slowly track it back to zero. This feature exists to offset any small zero drift of the load cell or initial warm up of the indicator. This tracking does not effect the calibrated span of the channel being monitored.



## KEY LOCKING

Access to the parameter set up pages of the menu and, optionally, the ZERO key can be disabled by the LOC function.

When in normal operation mode, press all four top keys

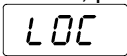
simultaneously to display 

You will now only be able to check and change channel, enter the peak hold function and, if possible, set zero.

Press the same four keys simultaneously to turn this function

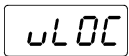
off. This will be indicated by 

## SPECIFICATION

Battery	6V lead-acid rechargeable
Battery life	35 hours with 350Ω bridge
Bridge excitation	5Vdc fixed
Bridge resistance	85Ω minimum
Span	0.6 to 7.5mV/V for full scale
Zero/tare	±100% of full range
Accuracy	±2 digits (±0.02% of full range)
Resolution	1:19999
Peak hold	500ms peak capture
Digital filtering	0.5 to 5 seconds
Operating temp.	-10°C to +50°C
Thermal drift	100ppm/°C max.